

24 HR REAL TIME / 960 HR TIME LAPSE RECORDER

User's Guide

SL820

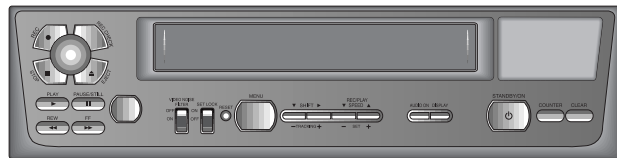



security labs

15540 Herriman Blvd. - Noblesville, IN 46060
1-800-774-0284 - www.security-labs.com

Be sure to read carefully and follow all the SAFETY INFORMATION on pages i, ii, iii.
Keep the manual in a safe place for future reference.

Safety information

	CAUTION RISK OF ELECTRIC SHOCK DO NOT OPEN	
CAUTION: TO REDUCE THE RISK OF ELECTRIC SHOCK, DO NOT REMOVE COVER (OR BACK). NO USER-SERVICEABLE PARTS INSIDE. REFER SERVICING TO QUALIFIED SERVICE PERSONNEL.		



The lightning flash with arrowhead symbol, within an equilateral triangle, is intended to alert the user to the presence of uninsulated “dangerous voltage” within the product’s enclosure that may be of sufficient magnitude to constitute a risk of electric shock.



The exclamation point within an equilateral triangle is intended to alert the user to the presence of important operating and servicing instructions in the literature accompanying the appliance.

WARNING : TO REDUCE THE RISK OF FIRE OR ELECTRIC SHOCK, DO NOT EXPOSE THIS APPLIANCE TO RAIN OR MOISTURE.
CAUTION : TO PREVENT ELECTRIC SHOCK, MATCH WIDE BLADE OF PLUG TO WIDE SLOT, FULLY INSERT.

IMPORTANT SAFEGUARDS

In addition to the careful attention devoted to quality standards in the manufacture of your video product, safety is a major factor in the design of every instrument. However, safety is your responsibility too. This sheet lists important information that will help to assure your enjoyment and proper use of the video product and accessory equipment. Please read them carefully before operating and using your video product.

Installation

- 1** Read and Follow Instructions- All the safety and operating instructions should be read before the video product is operated. Follow all operating instructions.
- 2** Retain Instructions- The safety and operating instructions should be retained for future reference.
- 3** Heed Warnings-Comply with all warnings on the video product and in the operating instructions.
- 4** Polarization- This video product is equipped with a polarized alternating -current line plug (a plug having one blade wider than the other). This plug will fit into the power outlet only one way.
This is a safety feature. If you are unable to insert the plug fully into the outlet, try reversing the plug. If the plug still fails to fit, contact your electrician to replace your obsolete outlet. To prevent electric shock, do not use this polarized plug with an extension cord, receptacle, or other outlet unless the blades can be fully inserted without blade exposure. If you need an extension cord, use a polarized cord.
- 5** Power Sources-This video product should be operated only from the type of power source indicated on the marking label. If you are not sure of the type of power supply to your

home, consult your video dealer or local power company. For video products intended to operate from battery power, or other sources, refer to the operating instructions.

- 6** Overloading- Do not overload wall outlets of extension cords as this can result in a risk of fire or electric shock. Overloaded AC outlets, extension cords, frayed power cords, damaged or cracked wire insulation, and broken plugs are dangerous. They may result in a shock or fire hazard. Periodically examine the cord, and if its appearance indicates damage or deteriorated insulation, have it replaced by your service technician
- 7** Power-Cord Protection- Power-supply cords should be routed so that they are not likely to be walked on or pinched by items placed upon or against them, paying particular attention to cords at plugs, convenience receptacles, and the point where they exit from the video product.
- 8** Ventilation- Slots and openings in the case are provided for ventilation to ensure reliable operation of the video product and to protect it from overheating. These openings must not be blocked or covered. The openings should never be blocked by placing the video product on a bed, sofa, rug, or other similar surface. This video product should never be placed near or over a radiator or heat register. This video product should not be placed in a built-in installation such as a bookcase or rack unless proper ventilation is provided or the video product manufacturer's instruction's have been followed.
- 9** Attachments- Do not use attachments unless recommended by the video product manufacturer as they may cause a hazard.
- 10** Water and Moisture- Do not use this video product near water- for example, near a bath tub, wash bowl, kitchen sink or laundry tub, in a wet basement, or near a swimming pool and the like. Caution : Maintain electrical safety. Powerline operated equipment or accessories connected to this unit should bear the UL listing mark or CSA certification mark on the accessory itself and should not be modified so as to defeat the safety features. This will help avoid any potential hazard from electrical shock or fire. If in doubt, contact qualified service personnel.
- 11** Accessories- Do not place this video product on an unstable cart, stand, tripod, bracket, or table. The video product may fall, causing serious injury to a child or adult as well as serious damage to the video product. Use this video product only with a cart, stand, tripod, bracket, or table recommended by the manufacturer or sold with the video product. Any mounting of the product should follow the manufacturer's instructions and use a mounting accessory recommended by the manufacturer.
- 12** A video product and cart combination should be moved with care. Quick stops, excessive force, and uneven surfaces may cause the video product and cart combination to overturn.
- 13** Power Lines- An outside antenna system should not be located in the vicinity of overhead power lines, other electric light or power circuits, or where it can fall into such power lines or circuits. When installing an outside antenna system, extreme care should be taken to keep from touching or approaching such power lines or circuits as contact with them might be fatal. Installing an outdoor antenna can be hazardous and should be left to a professional antenna installer.



Use

- 14** Cleaning- Unplug this video product from the wall outlet before cleaning. Do not use liquid cleaners or aerosol cleaners. Use a damp cloth for cleaning.
- 15** Object and Liquid Entry- Never push objects of any kind into this video product through openings as they may touch dangerous voltage points or "short-out" parts that could result in a fire or electric shock. Never spill liquid of any kind on the video product.
- 16** Lightning- For added protection for this video product during a lightning storm, or when it is left unattended and unused for long periods of time, unplug it from the wall outlet and disconnect the antenna or cable system. This will prevent damage to the video product due to lightning and power line surges.

Service

- 17** Servicing- Do not attempt to service this video product yourself as opening or removing covers may expose you to dangerous voltage or other hazards. Refer all servicing to qualified service personnel.
- 18** Conditions Requiring Service- Unplug this video product from the wall outlet and refer servicing to qualified service personnel under the following conditions.
 - A. When the power-supply cord or plug is damaged.
 - B. If liquid has been spilled, or objects have fallen into the video product.
 - C. If the video product has been exposed to rain or water.
 - D. If the video product does not operate normally by following the operating instructions. Adjust only those controls that are covered by the operating instructions. Improper adjustment of other controls may result in damage and will often require extensive work by a qualified technician to restore the video product to its normal operation.
 - E. If the video product has been dropped or the cabinet has been damaged.
 - F. When the video product exhibits a distinct change in performance- this indicates a need for service.
- 19** Replacement Parts- When replacement parts are required, have the service technician verify that the replacements he uses have the same safety characteristics as the original parts. Use of replacements specified by the video product manufacturer can prevent fire, electric shock, or other hazards.
- 20** Safety Check- Upon completion of any service or repairs to this video product, ask the service technician to perform safety checks recommended by the manufacturer to determine that the video product is in safe operating condition.
- 21** Wall or Ceiling Mounting- The product should be mounted to a wall or ceiling only as recommended by the manufacturer.
- 22** Heat- The product should be situated away from heat sources such as radiators, heat registers, stoves, or other products (including amplifiers) that produce heat.

Note to CATV system installer

This reminder is provided to call the CATV system installer's attention to Section 820-40 of the NEC which provides guidelines for proper grounding and, in particular, specifies that the cable ground shall be connected to the grounding system of the building, as close to the point of cable entry as practical.

Contents

Locations of controls and indicators	1
Front Panel	1
Digital Display	2
Back Panel	4
Remote Control	5
Connections	6
Video Cassettes Tapes	7
Types of On-screen displays and Display Sequence	8
Setting the Clock	10
Changing the On-Screen Display	12
Normal Recording	14
Program Timer Recording	16
Alarm Recording	20
Panic Recording	23
Series Recording	23
Autorepeat Recording	25
Normal Playback	26
Normal Playback	26
Tracking Control / Vertical Lock Control	26
Audio Playback	27
Special Playback	28
Picture Search	28
Still Image / Slow	28
Recording Check / Alarm Search	29
Alarm Scan / Index Search	30
Other Functions	31
Tape counter (Zero Search)	31
Setting the Security Lock (Set Lock)	32
Setting the Remote Control Lock Out	32
Setting the SW Out Terminal Output	33
Setting the Buzzer	34
Checking the Alarm Recording Times	35
Checking Power Loss Times	35
Setting In/Out terminals	36
Daily Inspection	41
Troubleshooting Guide	42
Specifications	44

Locations of controls and indicators

Front Panel

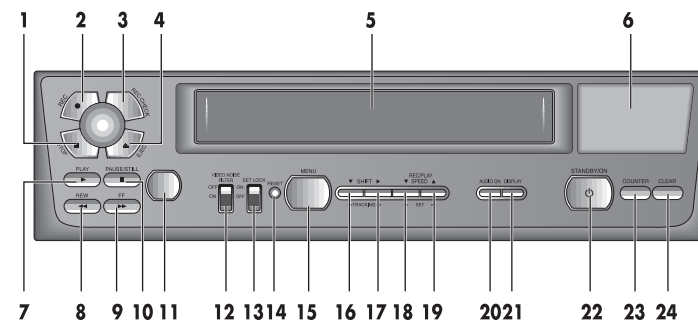

- | | |
|------------------------------|--|
| 1 STOP button | 15 MENU button |
| 2 REC button | 16 SHIFT(▼) / TRACKING (-) button |
| 3 REC CHECK button | 17 SHIFT(▶) / TRACKING (+) button |
| 4 EJECT button | 18 REC/PLAY SPEED(▼) button (SET - button) |
| 5 CASSETTE LOADING DOOR | 19 REC/PLAY SPEED(▲) button (SET + button) |
| 6 DISPLAY PANEL | 20 AUDIO ON button |
| 7 PLAY button | 21 DISPLAY button |
| 8 REW button | 22 STANDBY/ON button |
| 9 FF button | 23 COUNTER button |
| 10 PAUSE/STILL button | 24 CLEAR button |
| 11 REMOTE SENSOR | |
| 12 VIDEO NOISE FILTER switch | |
| 13 SET LOCK switch | |
| 14 RESET button | |

Digital Display



- 1 Operation Indicators** display the actual operation mode.

	Operation Mode	Indicator
1	Record (REC)	REC
2	Record pause (REC PAUSE)	REC +
3	Playback (PLAY)	▶
4	Still image (STILL)	▶ +
5	Fast forward (FF)	▶▶
6	Rewind (REW)	◀◀
7	CUE (CUE)+	▶ + ▶▶
8	Review (REVIEW)+	▶ + ◀◀
9	Slow (Pause Still + FF, Pause Still + REW)	+ ⚡

- 2 Cassette indicator :** Comes on when a cassette is loaded.
- 3 Record check indicator :** REC
Flashes on during record check.
- 4 Alarm indicator :** Flashes during alarm recording, and stops flashing after alarm recording ceases.
- 5 Timer Recording indicator :** Comes on when in timer recording stand-by mode, or during a timer recording.

- 6 Power Loss indicator :** Flashes after power loss.
- 7 CNT indicator :** CNT
Comes on when the tape or alarm counter is on.
- 8 SPD indicator :** SPD
Comes on when the digital display is showing the record or play speed.
- 9 VIDEO NOISE FILTER indicator :** H.P
Comes on when the VIDEO NOISE FILTER switch is set to the "OFF" position, indicating that a "High Resolution Picture" is being displayed.
- 10 S.REC indicator :** S.REC
Comes on when "YES" is selected in the menu for the series recording.
- 11 R.REC indicator :** R.REC
Comes on when "YES" is selected in the menu for the repeat recording.
- 12 SET LOCK SW indicator :** Comes on when the SET LOCK sw is set to the "ON" position.

13 Mode display

- **TAPE COUNTER** display (eg:10:HOUR,59:MINUTE)
- Maximum Hour : 19 - Maximum Minute : 59
- **ALARM COUNTER** display (eg: A:Alarm , 32:Alarm No.)
- **PLAY/REC SPEED** display (eg: 18H:Play/Recording Speed)
- **TIME** display (eg: 7:HOUR , 07:MINUTE)
- **ERROR** display (eg: E:Error , 04:Error No.)
- E-01 : The cassette cannot be loaded or unloaded.
- E-02 : The tape stops.
- E-03 : The drum can not rotate properly.
- E-04 : The tape is cut/broken.
- **AUDIO ON** display (eg: A:Audio , 18H:Play Speed)

Back Panel

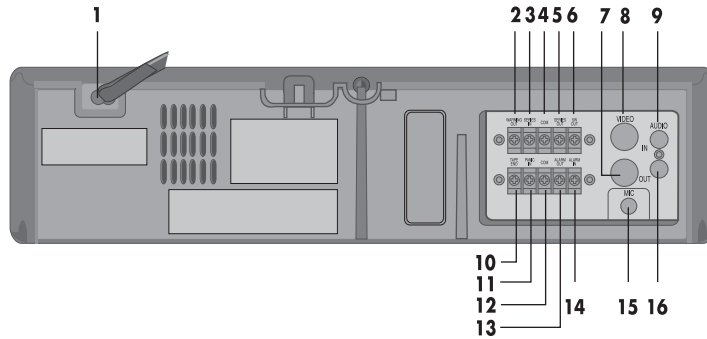

- 1 AC POWER CORD
- 2 WARNING OUT terminal
- 3 SERIES IN terminal
- 4 COM terminal
- 5 SERIES OUT terminal
- 6 SW OUT terminal
- 7 VIDEO OUT jack
- 8 VIDEO IN jack
- 9 AUDIO IN jack
- 10 TAPE END terminal
- 11 PANIC IN terminal
- 12 COM terminal
- 13 ALARM OUT terminal
- 14 ALARM IN terminal
- 15 MIC(microphone input) jack
- 16 AUDIO OUT jack

Remote Control

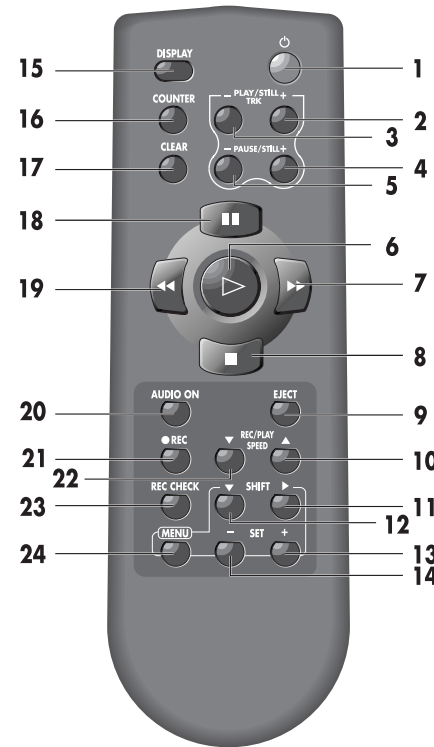

- 1 POWER button
- 2 PLAY/STILL TRACKING + button
- 3 PLAY/STILL TRACKING - button
- 4 PAUSE/ STILL + button
- 5 PAUSE/STILL - button
- 6 PLAY ► button
- 7 FF ►► button
- 8 STOP ■ button
- 9 EJECT button
- 10 REC/PLAY SPEED ▲ button
- 11 SHIFT ► button
- 12 SHIFT ▼ button
- 13 SET + button
- 14 SET - button
- 15 DISPLAY button
- 16 COUNTER button
- 17 CLEAR button
- 18 PAUSE/STILL button
- 19 REW ◀◀ button
- 20 AUDIO ON button
- 21 ● REC button
- 22 REC/PLAY SPEED ▼ button
- 23 REC CHECK button
- 24 MENU button

Connections

Connect the video camera and monitor TV as shown in the figure below.

NOTE : Make sure to turn the power off on all devices before making the connections.

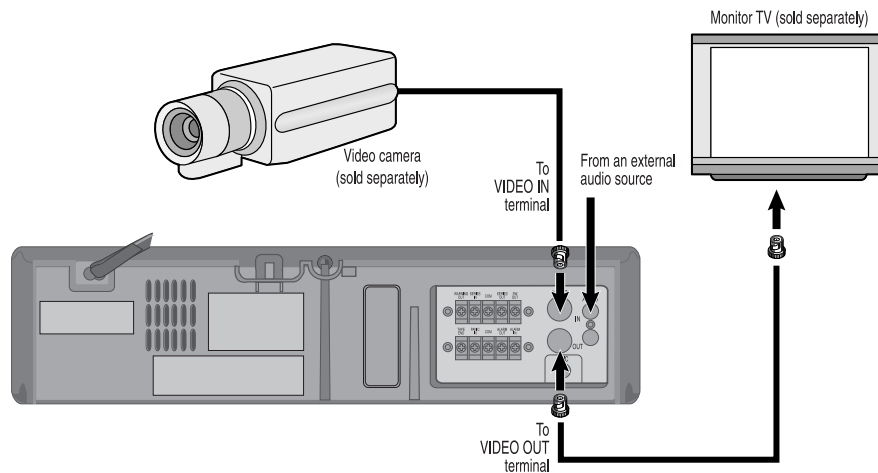

Power Cord Installation

Insert the plug of the power cord into an outlet.

Video Cassettes Tapes

Use only video cassette tapes bearing the **VHS** logo.

This VCR was primarily designed for use with T-120 cassette tapes. It is recommended to use T-120 VHS or T-160 VHS video cassette tapes for optimal performance.



- If you try to record on a cassette without the erasure-prevention tab, the VCR will eject the cassette.
- If the **TIMER** button is pressed when a cassette without the erasure-prevention tab is loaded, the VCR will eject the cassette, the timer recording indicator (☐) will start flashing and a buzzer will sound if "YES" is set in the menu for buzzer.



- When the cassette is loaded, the cassette indicator "●" will light on the display panel.
- The counter display will switch to the reset counter "OH OOM OOS" display on the monitor screen. ("OH OOM" on the display panel.)



- Do not insert any object in the cassette loading slot, as that may cause injury and damage to the VCR.
- If your hand gets stuck in the cassette loading slot, unplug the power cord and consult the dealer where the unit was bought. Do not forcibly pull the hand out as that may cause severe injuries.

Handling Cassette Tapes

Cassette tapes should always be stored vertically in their cases, away from high temperatures, magnetic fields, direct sunlight, dirt, dust and locations subject to mold formation.

Do not tamper with the cassette mechanism.

Never touch the tape with your fingers.

Protect cassette tapes from shocks or strong vibrations.

To Protect your recordings

After having recorded a tape, if you wish to keep the recording, use a flathead screwdriver to break off the erasure-prevention tab on the cassette.

To record again on a tape without erasure-prevention tab, cover the hole with adhesive tape.

Erasure-prevention tab



To prevent accidental erasure, remove the tab after recording.

To record again, cover the hole with vinyl tape.

Loading

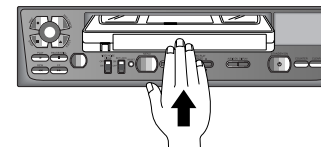

Place the cassette, label side up, in the loading slot. Gently push the center of the cassette until it is loaded automatically.

Unloading

In **STOP** mode, press the **EJECT** button. The cassette is automatically ejected.

Types of On-screen displays and Display Sequence

- If the VCR is in timer recording stand-by mode (the “” indicator is displayed on the display panel), the on-screen displays will not be available. First press the STANDBY/ON(POWER) button, to cancel the recording stand-by mode, then proceed with the VCR programming. When finished, press the STANDBY/ON(POWER) button again to return the VCR to timer recording stand-by mode.
- When a menu is displayed, recording will not be possible.
- Press the MENU button three times, the setting procedure is now completed and the normal screen is displayed.
- During recording or playback the menus cannot be displayed.

- A**
- Press the MENU button. (First time)
 - Press the SHIFT \blacktriangledown button to move the arrow mark (\blacktriangleright) downward for the desired item.
 - Press the SHIFT \blacktriangleright button to select the desired item, then the desired menu is displayed.
 - Press the MENU button to return to the normal screen from the initial menu.
- B**
- Press the SHIFT \blacktriangleright button to select the desired item.
 - Press the SET - (or +) button to set or Press the SHIFT \blacktriangleright button to select “YES” or “NO”.
 - Press the MENU button to return to the initial menu.
- C**
- Press the SHIFT \blacktriangleright (or SHIFT \blacktriangledown) button to select the desired item.
 - Press the SET - (or +) button to set or Press the SHIFT \blacktriangleright button to select.
 - Press the MENU button to return to the previous menu.

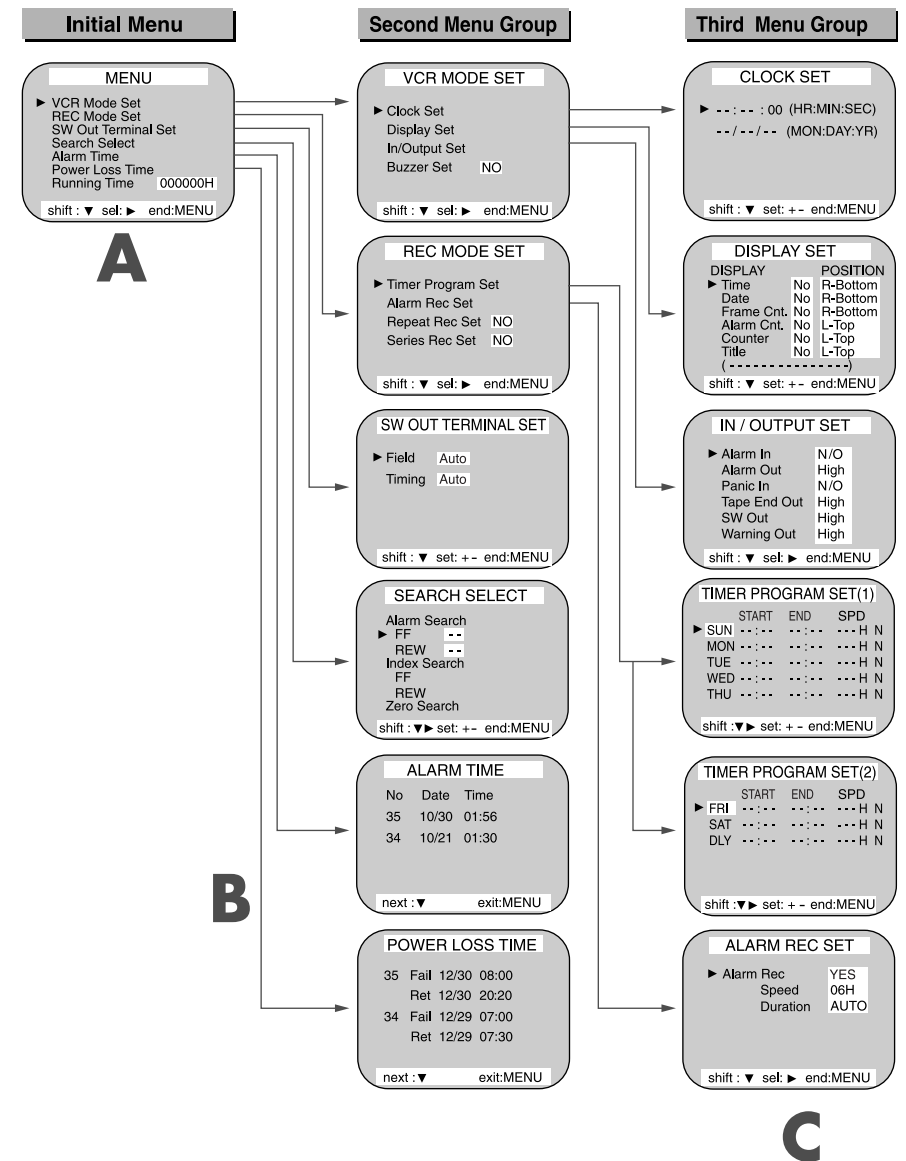

Setting the Clock

Example: To set the clock to April 12, 2002 at 9:30

Clock Setting

- 1 Turn the power on to all devices used.
- 2 Press the MENU button, the initial MENU is displayed. The arrow mark (▶) is located in "VCR Mode Set".

Initial MENU

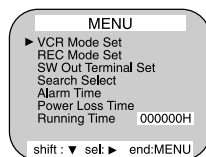

- 3 Press the SHIFT ▶ button, the VCR MODE SET menu is displayed. The arrow mark (▶) is located in "Clock Set".

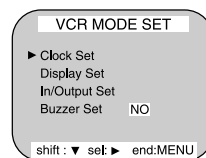

- 4 Press the SHIFT ▶ button, the CLOCK SET menu is displayed.

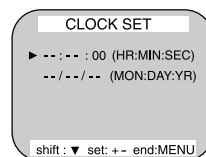

- 5 Press the SET - (or +) button to set the hours (eg : 09), then press the SHIFT ▶ button.

- 6 Press the SET - (or +) button to set the minutes (eg : 30), then press the SHIFT ▶ button.
- 7 The seconds are already set to "00".
- 8 Press the SHIFT ▶ button.
- 9 Press the SET - (or +) button to set the month (eg : 04), then press the SHIFT ▶ button.
- 10 Press the SET - (or +) button to set the day (eg : 12), then press the SHIFT ▶ button.
- 11 Press the SET - (or +) button to set the year (eg : 02 for 2002).
 - The last 2 digits only are displayed.
 - The day of the week is set automatically.
- 12 Press the MENU button three times, the normal screen is displayed.
 - The setting procedure is now complete.

Changing the On-Screen Display

Selecting the On-screen Display

You can select whether or not to display the time, date, frame counter, alarm counter, counter title.

- 1 Turn the power on to all devices used.
- 2 Press the MENU button. The initial MENU is displayed. The arrow mark (▶) is located in "VCR Mode Set".

Initial MENU

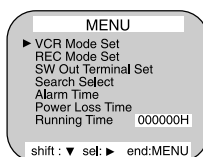

- 3 Press the SHIFT ▶ button to select the VCR Mode Set, then the VCR MODE SET menu is displayed.

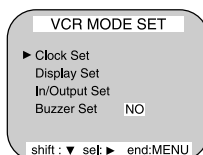

- 4 Press the SHIFT ▼ button, until the arrow mark (▶) points "Display set".
- 5 Press the SHIFT ▶ button to select Display Set, then the DISPLAY SET menu is displayed.

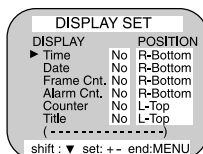

The items for which "YES" is set are recorded. The items for which "NO" is set at step 6 above are not recorded.

- 6 Press the SET - (or +) button to set "YES" for the functions described below.

Time.....The time is displayed.

DateThe Month-Day-Year is displayed.

Frame CntThe number of frames is displayed.

Alarm CntThe number of alarms is displayed.

CounterThe counter is displayed.

Title.....The title is displayed.

• A maximum of 20 characters can be used. (letters, numbers or spaces)

- 7 Press the SHIFT ▶ button to set the display position.

- 8 Press the SET - (or +) button to set the position of the time, date, frame cnt. alarm cnt. to "L-Bottom (or R-Bottom)".

• If any of 4 items is set, the position of 4 items is changed identically.

- 9 Press the SET - (or +) button to set the position of the counter and title to "C-Top" (or "R-Top" or "L-Top").

If one of 2 items is set, the position of 2 items is changed identically.

L-Top / C-Top / R-Top

: Left Top / Center Top / Right Top

L-Bottom / R-Bottom

: Left Bottom / Right Bottom

- 10 Press the MENU button three times, the normal screen is displayed.

The setting procedure is now complete.

Normal Recording



- If the Repeat Rec Set is set to "NO" in the REC MODE SET menu, recording will continue to the end of the tape, then stop and the tape will be ejected.



- A tape recorded on this VCR cannot be played back on another make of time lapse VCR.
- If you press on the REC button and the loaded cassette has no erasure-prevention tab, the VCR will eject the cassette.
- During recording, the Menu button will not function (the menu cannot be accessed).



- If you playback the recorded part where recording check was performed, noise may appear.
- If you change the recording speed during recording, noise or missing signal may result.

Normal Recording

- 1 Turn the power on to all devices used.
- 2 Load a cassette tape with erasure prevention tab in place.
- 3 Press the REC/PLAY SPEED ▼ (or ▲) button to set the recording speed.
 - The recording speed is displayed on-screen and on the display panel.
 - If you don't want to record the recording speed, counter, title, time, date etc, press the DISPLAY button, then start recording.
- 4 Press the REC button.
 - The "REC" indicator is displayed on the display panel and recording starts.
- 5 To stop recording, press the STOP button.

<Recording Speed>

Recording Speeds & Duration T-120	Recording Duration T-160	Recording Intervals	Rec. Fields /Sec.	Audio Record- ing	Tape Motion
2(SP)	2.67	1/60 Sec	60	YES	Continuous
6(EP)	8	1/60 Sec	60		
18(EP)	24	3/60 Sec	20		
24(SP)	32	0.2	5		
36(SP)	48	0.3	3.33	NO	Intermittent
48(SP)	64	0.4	2.5		
72(SP)	96	0.6	1.67		
96(SP)	128	0.8	1.25		
120(SP)	160	1.0	1		
168(SP)	224	1.4	0.71		
240(SP)	320	2.0	0.5		
360(SP)	480	3.0	0.33		
480(SP)	640	4.0	0.25		
720(SP)	960	6.0	0.17		
960(SP)	1280	8.0	0.125		

- ⚡ (SP) means to be recorded by SP heads.
- (EP) means to be recorded by EP heads.



- During pause, the image appears on screen but it is not recorded.
- If a recording pause continues for 5 minutes or more, the VCR will go into stop mode to avoid damage to the tape.

Record Pause

Recording can be interrupted temporarily.

- 1 Press the PAUSE/STILL button during recording.
 - The "REC" and "II" indicators are displayed on the display panel.
- 2 To resume recording, press the REC button, or press the PAUSE/STILL button again.

Program Timer Recording

There are two program timer recording methods, daily recording or recording on certain days of multiple weeks (weekly recording).

Example 1 : To record on every Thursday from 10 : 00 to 18 : 00 , in 18-hour mode (recording speed)

- 1 Make sure that the set date and time are correct.
- 2 Load a cassette tape with erasure prevention tab in place.
- 3 Press the MENU, SHIFT ▼ , SHIFT ► , SHIFT ► buttons in sequence to display the TIMER PROGRAM SET(1) menu.

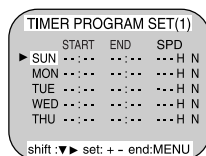

- The white block cursor is on "SUN"(Sunday).
- 4 Press the SHIFT ▼ button, until the cursor is on "THU".
 - 5 Press the SHIFT ► button.
 - The cursor is moved to the recording start hour position.
 - 6 Press the SET - (or +) button to set the recording start hour (eg : 10), then press the SHIFT ► button.
 - The cursor is moved to the recording start minutes position.
 - 7 Press the SET - (or +) button to set the recording start minute (eg : 00), then the SHIFT ► button.
 - The cursor is moved to the recording stop hour position.
 - 8 Press the SET - (or +) button to set the recording stop hour (eg : 18), then press the SHIFT ► button.
 - The cursor is moved to the recording stop minutes position.



- If the set stop time is earlier than or the same time as the set start time, the VCR will consider the stop time to be the following day.

- 9 Press the SET - (or +) button to set the recording stop minutes (eg : 00), then press the SHIFT ► button.
- 10 Press the SET - (or +) button to select the recording speed (eg : 18), then press the SHIFT ► button.
 - The cursor is moved to the NY position.
- 11 Press the SET - (or +) button to select "Y".
Y recording will take place
N recording will not take place

Programmed timer recording Example 1

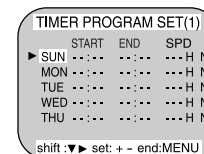

- Repeat steps 4 to 11 to program timer recordings for other days of the week.
- To set two or more timer recordings the same day of the week, press the SHIFT ▼ button, until the cursor located in the day of the week for the second recording, then press the SET - (or +) button, to set the desired day of the week. With each press of the SET - (or +) button, the day will change as indicated below.

SET - : ← direction , SET + : → direction

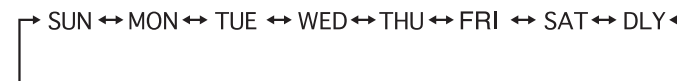

- To modify or cancel timer recording, press the STANDBY/ON(POWER) button to cancel the timer recording mode.

- 12 Press the MENU button three times, the normal screen is displayed.
- 13 Press the STANDBY/ON(POWER) button.
 - The timer recording indicator "⏸" will light on the display panel. The VCR is now in timer recording stand-by mode.

Example 2 : To record everyday from 10 : 00 to 18 : 00, in 18-hour mode (recording speed)

- 1 Repeat steps 1 to 3.
- 2 Press the SHIFT ▼ button, until the cursor is on “DLY”. The MENU below is displayed.

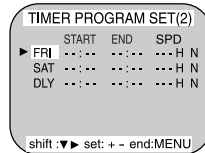

- 3 Repeat steps 5 to 13.

Programmed timer recording Example 2

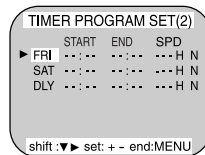

Changing a Program Timer Recording

- 1 Press the MENU, SHIFT ▼, SHIFT ▶, SHIFT ▶ buttons in sequence to display the TIMER PROGRAM SET(1) menu.
- 2 Press the SHIFT ▶ (or ▼) button, until the cursor is located in the setting to correct.
- 3 Press the SET - (or +) button, to correct the setting.
 - Press the MENU button three times until the normal screen is displayed.
- 4 Press the STANDBY/ON(POWER) button.

To Cancel a Program Timer Recording

- 1 Repeat step 1 above.
- 2 Press the SHIFT ▶ (or ▼) button until the cursor is located in the “Y” corresponding to the timer recording to cancel.
- 3 Press the SET - (or +) button, to select “N”.
- 4 Press the MENU button three times until the normal screen is displayed.
- 5 Press the STANDBY/ON(POWER) button.
 - The clear button can erase the programmed timer recording in the line that the cursor is located.

Notes...

- During timer recording all the buttons on the VCR, except the STOP button, are disabled. If the STOP button is pressed for three seconds during timer recording, the recording will stop. During timer recording stand-by, press the STANDBY/ON(POWER) button if the buttons do not respond.
- If there is a power loss, the recording will be interrupted. When the power is restored, the recording will resume if the stop time has not yet been reached, and “▶” will be flashing on the display panel. The VCR internal battery is completely charged after the VCR has been connected to an AC power outlet for 48 hours, and it will maintain all the VCR settings memory for up to 30 days.
- Set the timer recordings so that the recording times do not overlap. If they do, the one with the earliest recording start time will have priority.

(See chart below)

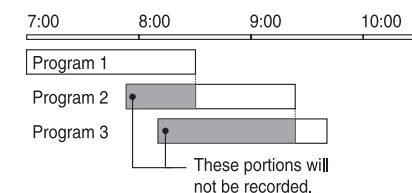

- If the cassette tape is ejected while timer recording is set, the buzzer will be heard 5 times (when the buzzer function is set to “YES”).

Alarm Recording

Alarm Recording Setting

Alarm recording is performed when there is an input (trigger) at the ALARM IN terminal, “(▶)” is displayed on the display panel.

- 1 Make all necessary connections.
- 2 Press the MENU, SHIFT ▼, SHIFT ▶ buttons in sequence to display the REC MODE SET menu.
- 3 Press the SHIFT ▼ button until the arrow mark (▶) points to ALARM REC SET.
- 4 Press the SHIFT ▶ button to display the ALARM REC SET menu.

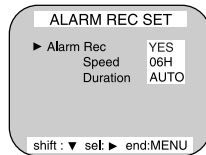

- During alarm recording all buttons are disabled except the STOP button. If the STOP button is pressed, the alarm recording will stop.
- If an alarm trigger is received while alarm recording is in progress, the recording duration for the second alarm will be calculated from that point.
- When there is a power loss during alarm recording, if the power is restored within the recording set duration, alarm recording will continue.
- When you select 'Alarm Duration' as 20sec, 30sec, 40sec or 1min, alarm search error may happen. Therefore confirm it in 'Alarm Time' menu and scan it.

- 5 Press the SHIFT ▶ button to select “YES” or “NO”.
 - YES . . . The alarm recording takes place when there is alarm trigger input
 - NO . . . The alarm recording does not take place
- 6 Press the SHIFT ▼ button to set the Alarm speed.
- 7 Press the SHIFT ▶ button to select the desired recording speed.
 - 2H . . . 2-hour mode recording
 - 6H . . . 6-hour mode recording
 - 18H . . . 18-hour mode recording
 - 24H . . . 24-hour mode recording
- 8 Press the SHIFT ▼ button to set the alarm duration.
- 9 Press the SHIFT ▶ button to select the desired recording duration.
 - Auto : Records as long as the alarm signal is received. (Minimum 2 minutes is recorded.)



- Alarm Counter Reset can be performed by pressing the CLEAR key in "Alarm Time" of Initial Menu screen.

- Auto / 20sec / 30sec / 40sec / 01min / 02min / 3min / 5min / 10min / 15min / 20min / 25min / 30min : Recording for the set duration. (min : minute)
- T.END : Records until the tape end is reached when there is alarm trigger input.

Alarm Recording Counter Display

During alarm recording, “(▶)” will be flashing on the display panel.

The maximum display number of alarm triggers is “35”, at the next alarm recording the counter will indicate “00”.

Connecting to a Monitor for Normal Recording

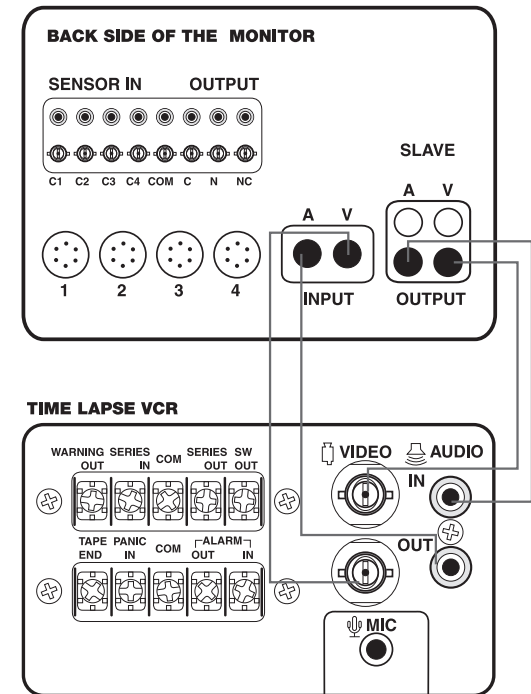

Connecting to a Monitor for Alarm Recording

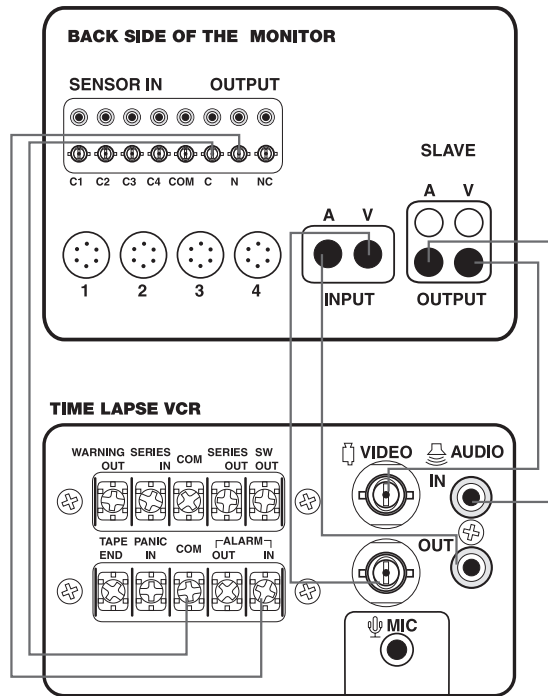

Panic Recording

This feature is similar to an alarm recording, but the recording time is not pre-selected.

When there is a panic input at the PANIC IN Terminal, recording will start and continue for up to 2 hours.

Series Recording

Using 2 VCRs or more, the series recording function lets you switch recording from one unit to the next (only with VCRs of the same model as this one).

Series Recording Setup

- 1 Connect 2 VCRs or more as illustrated on next page.
- 2 Set the following items as indicated.

Item	VCR No.1	VCR No.2 and on
Cassette tape	Loaded	Loaded
Operation mode	Stop	Stop
Repeat Rec Set	"NO"	"NO"
Series Rec Set	"YES"	"YES"
Timer recording	OFF (not set)	OFF (not set)
Security lock switch (SET LOCK switch)	"OFF"	"ON"

- 3 Press the REC button on VCR No.1.

- Recording will start in series recording mode.



- During series recording, autorepeat recording or timer recording are not possible.
- If in the REC MODE SET menu, "Series Rec Set" is set to "NO", series recording will not be possible.

- 4 Set the security lock on VCR No.1.
 - *When the end of the tape on VCR No.1 is reached, the output at the SERIES OUT terminal will switch signal. This will start recording on VCR No.2, the tape will stop and be ejected on VCR No.1.*

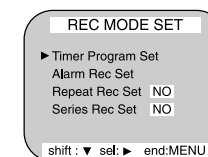
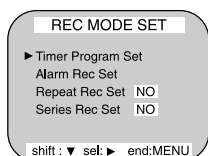
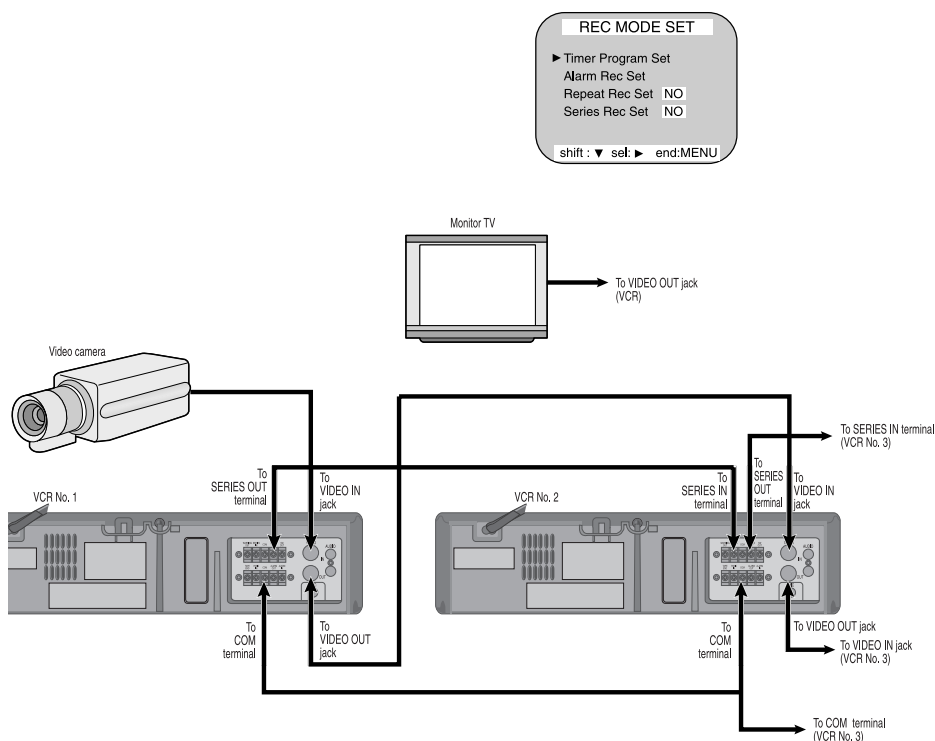

Autorepeat Recording

Autorepeat Recording

The same tape can be recorded over many times. Please note that if you activate this feature you will lose the entire previous recording.

- 1 Press the MENU, SHIFT ▼, SHIFT ► button in sequence to display the REC MODE SET menu.



- *If during autorepeat recording there is an alarm trigger, "▶" is displayed on the display panel and alarm recording will take place. Autorepeat recording will continue after alarm recording has completed its programmed duration.*

- 2 Press the SHIFT ► button to make the arrow mark (▶) point to Repeat Rec Set.
- 3 Press the SHIFT ► button to set the desired autorepeat recording mode.

NO Autorepeat recording doesn't take place.

YES Autorepeat recording takes place.

"R.REC" will light on the display panel.

- 4 Press the MENU button two times, the normal screen is displayed.
 - *The setting procedure is now complete.*
- 5 Press the REC button.
 - *Recording will start. When the tape's end is reached, the VCR will rewind it to the beginning regardless of the counter memory, and recording will resume.*

Normal Playback



- A slow motion effect or accelerated playback effect can be achieved by using a slower or faster playback speed than the speed used for recording.



- If playback image isn't clear, adjust the screen by pressing TRACKING+/- button.

Normal Playback

- 1 Turn on the power to the TV monitor.
- 2 Load the video cassette tape.
- 3 Press the REC/PLAY SPEED ▼ (or ▲) button to select the playback speed.
 - The selected playback speed is displayed on the display panel.
 - A tape recorded with EP heads can be played in 6, 18, 36, 48, 72, 96, 120, 168, 240, 360, 480, 720 or 960-hour modes.
 - A tape recorded with SP heads can be played in 2, 24, 36, 48, 72, 96, 120, 168, 240, 360, 480, 720 or 960-hour modes.
 - The picture quality recorded by EP heads can be lower than SP heads.
- 4 Press the PLAY button.
 - Playback starts.
- 5 To stop playback, press the STOP button.
 - To advanced or rewind the tape, press the FF/CUE or REW/REVIEW button.

Tracking Control

- 1 While looking at the playback picture, press and hold the TRACKING + button to minimize the noise.
- 2 If it cannot be minimized, press the TRACKING - button.
- 3 If there is noise in the image during playback, push the 'pause' button, while looking at the paused picture press and hold the TRACKING + or - button until you get a clear stable picture.

Vertical Lock Control

During still image mode,

- 1 Press the TRACKING + button to reduce the vertical rolling of the image.
- 2 If it cannot be corrected, press the TRACKING - button.



- Noise will appear in the image when audio playback is used in 18-hour or 24-hour mode.

Audio Playback

Audio playback is only possible in 2-hour, 6-hour, 18-hour and 24-hour modes.

The playback speed has to be the same as the recording speed, for normal playback of the audio.

For a tape recorded in 2-hour, 6-hour, 18-hour and 24-hour modes, to playback the audio, press the AUDIO ON button after pressing the PLAY button. "A" will be displayed to the left of the playback speed on the display panel. Press the AUDIO ON button again to remove "A".

Special Playback



- During picture search, noise (horizontal bars) will appear in the picture.
- The sound is muted.



- If still mode continues for 5 minutes or more, the VCR will go into stop mode to avoid damaging the tape.
- If the image is unstable (rolling vertically), adjust the tracking control to correct.

Picture Search

- 1 Press the FF/CUE (or REW/REVIEW) button, during normal playback.
 - The image can be seen while the tape is advanced (or rewound) at high speed.
- 2 To return to normal playback, press the PLAY button.

Still Image

- 1 Press the PAUSE/STILL button, during normal playback.
 - A still image can be viewed.
- 2 To return to normal playback, press the PLAY button.
 - With each press of the PAUSE/STILL button, the still image is advanced one image (frame).

Slow

- 1 With each press of the FF button, during still image mode, the slow speed will change as indicated below. 1/30times → 1/15times → 1/5times (forward direction)
- 2 With each press of the REW button, during still image mode, the slow speed will change as indicated below. 1/30times → 1/15times → 1/5times (forward direction)
- 3 To return to normal playback, press the PLAY button.



- During recording check operations, recording is suspended momentarily.

Recording Check

During recording, press the REC CHECK button.

- The tape will be rewound for about 5 seconds and slow play mode will be performed. The VCR will then return to the previous recording mode.

Alarm Search

- 1 Press the Menu button to display the initial menu.
- 2 Press the SHIFT ▼ button to select Search Select, then press the SHIFT ► button to display the SEARCH SELECT menu.

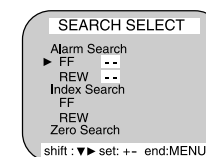

- 3 Move the arrow mark (►) to FF or REW in the Alarm Search mode as you want to search.
- 4 Press the SET -(or +) button to enter the number of alarm marks you want to search, press the SHIFT ► button to search forward or in reverse.
 - The display returns to the normal screen.
 - The VCR will locate the desired alarm recording and begin playback.

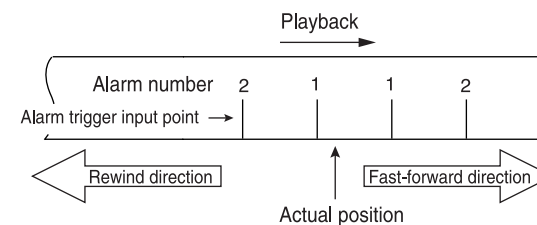

Alarm Scan

- 1 Repeat steps 1 to 3.
- 2 Press the SHIFT ► button to search forward or in reverse without entering a specific alarm number.
 - The display returns to the normal screen.
 - The VCR will advance (or rewind) the tape at high speed, and playback the first 5 seconds of every alarm recording.
 - To cancel the alarm scan mode, press the STOP button.
- 3 While the desired recording is being played back, press the PLAY button.
 - Playback will start, and alarm scan is cancelled.

Index Search

- 1 Repeat steps 1 to 2.
- 2 Move the arrow mark (►) to the FF or REW in the Index Search mode as you want to search.
- 3 Press the SHIFT ► button to search forward or in reverse.
 - The display returns to the normal screen.
 - The VCR will advance (or rewind) the tape at high speed and playback the first 5 seconds of every normal recording.
 - To cancel the index search mode, press the STOP button.
- 4 While the desired recording is being played back, press the PLAY button.
 - Playback will start, and index search is cancelled.



- In the index search mode, SHIFT ► button should be used to search forward or in reverse (Index FF / REW).

Other Functions



- When you insert a cassette, the counter always resets to zero.
- There is no tape counter indication for the blank portions of tape.
- In the 2-hour recording speed mode only, the tape counter indicates real hours, minutes and seconds.
- In the other SP recording speed modes (24H, 36H), the tape counter indication is a ratio of the 2-hour mode base indication. (In 24-hour recording mode, each "second" of the tape counter actually represents approximately $24/2 = 12$ real seconds.)
- There may be a slight discrepancy between the position shown on the tape counter and the actual tape position.
- When rewinding the tape past the "0H 00M 00S" position ("0H 00M" on the display panel), a minus(-) displayed.

Tape Counter (Zero Search)

Using the counter, it is easy to find a desired recording.

- 1 Press the CLEAR button, at the beginning of the desired recording.
 - The counter will be reset to "0H 00M 00S" (on screen).
 - The counter will be reset to "0H 00M" (on the display panel).
- 2 After recording or playback, press the Menu button to display the initial MENU.
- 3 Press the SHIFT ▼ button to move the arrow mark (►) to Search Select.
- 4 Press the SHIFT ► button to display the SEARCH SELECT menu. The SEARCH SELECT menu is displayed.

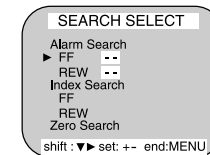



- 5 Press the SHIFT ▼ button to move the arrow mark (►) to Zero Search.
- 6 Press the SHIFT ► button to search the counter "0H 00M 00S" ("0H 00M" on the display panel).
 - The display returns to the normal screen.
 - The tape is rewound or advanced to the counter "0H 00M 00S" reading ("0H 00M" on the display panel).



- While the security lock is engaged, all commands are disabled.
- The security lock should not be engaged while a menu is displayed.

Setting the Security Lock (Set Lock)

The security lock function is designed to prevent accidental stopping of recording if the STOP button is pressed inadvertently.

- 1 Set the SET LOCK switch to "ON" position.
 - "  " is displayed on the display panel.
- 2 To cancel the security lock, set the SET LOCK switch to "OFF" position.
 - "  " indicator on the front panel digital display will turn off.



Setting the VIDEO NOISE FILTER (H.P)

Reduces the effects of video noise generated by outside sources, poor lighting conditions, improper coax cable, or camera performance, during the playback of a recording. The most typical setting for this switch is the "OFF" position.

- 1 Set the VIDEO NOISE FILTER switch to "OFF" position.
 - "H.P" is displayed on the front panel digital display indicating that the unit is producing a high resolution picture, up to 350 lines B/W.
- 2 To apply the VIDEO NOISE FILTER function, set the VIDEO NOISE FILTER switch to "ON" position.
 - "H.P" on the front panel digital display will turn off, indicating the playback resolution is being attenuated to 320 lines B/W.



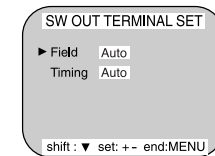

Setting the SW Out Terminal Output

Synchronization pulses for a multiplexer can be obtained from the SW OUT terminal.

- 1 Press the MENU button, to display the initial MENU.
- 2 Press the SHIFT  button to move the arrow mark () to SW OUT Terminal Set.
- 3 Press the SHIFT  button to display the SW OUT TERMINAL SET menu.



- If "TIMING" is set to FRAME (see step 6), "FRAME" will be indicated instead of "FIELD".
- In case of TimeLapse mode, refer to the "Recording Speed" Table of page 14.

- 4 Press the SHIFT  button to set "FIELD" (or "FRAME").
 - With each press of the SHIFT  button, the setting will change as indicated below.
- 5 Press the SHIFT  button, to select Timing.
- 6 Press the SHIFT  button to set the "TIMING".
 - AUTO . . . When you connect with external equipment, the field will be switched automatically.
 - FIELD . . . 1 pulse is output after each set number of fields. (VHS mode, 2H, 6H)
 - FRAME . . . 1 pulse is output after each set number frames. (VHS mode, 2H, 6H)
- 7 Press the MENU button, the normal screen is displayed.
 - The setting procedure is now complete.



In the following cases, the buzzer will be heard approximately 5 times.

- If the REC button is pressed while a cassette without erasure-prevention tab is loaded.
- If a cassette, without the erasure - prevention tab, is loaded while the timer is set.
- If there is a series recording input while a cassette without erasure-prevention tab is loaded.
- If the TIMER button is pressed without inserting a cassette.



- If "NO" is set, the buzzer will not operate.

Setting the Buzzer

- 1 Press the MENU button to display the initial MENU.
- 2 Press the SHIFT ► button to select VCR Mode Set. The VCR MODE SET menu is displayed.

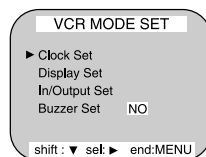

- 3 Press the SHIFT ▼ button to move the arrow mark (►) to Buzzer Set.
- 4 Press the SHIFT ► button to set "YES" for the functions described below.
 - The buzzer will be heard whenever a button is pressed.

Checking the Alarm Recording Times

- 1 Press the MENU button to display the initial MENU.
- 2 Press the SHIFT ▼ button to move the arrow mark (►) to Alarm Time.
- 3 Press the SHIFT ► button to display the ALARM TIME menu.
 - The number of alarm triggers and the 35 most recent alarm recording times are displayed.



- 4 Press the MENU button twice, the normal screen is displayed.

Checking Power Loss Times

- 1 Press the MENU button to display the initial MENU.
- 2 Press the SHIFT ▼ button to move the arrow mark (►) to Power Loss Time.
- 3 Press the SHIFT ► button to display the POWER LOSS TIME menu.
 - The number of power losses, and the 35 most recent power loss times are displayed.

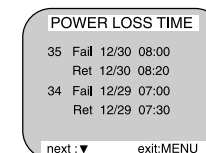

- 4 Press the MENU button twice, the normal screen is displayed.



- The data for the previous alarm recordings, past 35, is erased.



- POWER LOSS
the number of power losses and the date and time of the 35 most recent power losses and recoveries are displayed.

Setting In/Out terminals

- 1 Press the MENU button to display the initial MENU.
- 2 Press the SHIFT ► button to display the VCR MODE SET menu.
- 3 Press the SHIFT ▼ button to move the arrow mark (►) to In/Output Set.
- 4 Press the SHIFT ► button to display the IN/OUTPUT SET menu.
- 5 Press the SHIFT ▼ button to move the arrow mark (►) for the desired item.
- 6 Press the SHIFT ► button to set “N/C” or “N/O”, “High” or “Low”.

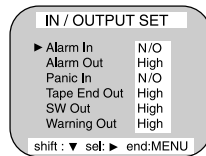

- 7 Press the MENU button three times, the normal screen is displayed.

• ALARM INPUT Terminal

This terminal is to connect PIR sensors, door contacts or any type of motion detector.

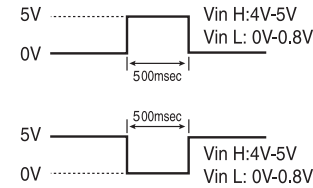

- 1) “N/C” (Normally CLOSED Switch Circuit)
If the input becomes DC 5V for 500 msec or more, the VCR starts alarm recording.
- 2) “N/O” (Normally OPEN Switch Circuit)
If the input becomes 0V for 500 msec or more, the VCR starts alarm recording.

• ALARM OUTPUT Terminal

This terminal is to connect to any external source, such as a siren, etc.

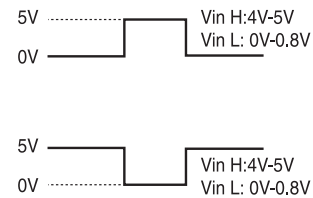

- 1) “High”
When an alarm input is received and the unit is recording, the output becomes DC 5V. Once the alarm recording is over, the output returns to 0V.
- 2) “Low”
When an alarm input is received and the unit is recording, the output becomes 0V. Once the alarm recording is over, the output returns to DC 5V.

• PANIC INPUT Terminal

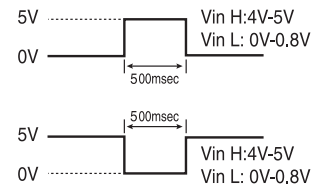

- 1) “N/C” (Normally CLOSED Switch Circuit)
If the input becomes DC 5V for 500 msec or more, the VCR starts panic recording.
- 2) “N/O” (Normally OPEN Switch Circuit)
If the input becomes 0V for 500 msec or more, the VCR starts panic recording.

• TAPE END(OUT) Terminal

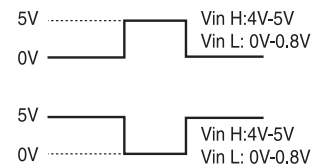

- 1) “High”
During recording, when the end of the tape is reached, the output becomes DC 5V.
- 2) “Low”
During recording, when the end of the tape is reached, the output becomes DC 0V.

• SW OUTPUT Terminal

While recording, a pulse signal (DC 5V) is output at the SW OUT terminal after each recording period. This terminal is usually connected to the sync input or sync trigger on a multiplexer (see Page 33).

1) Low

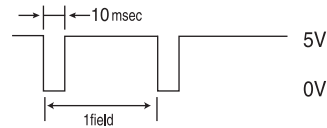

2) High

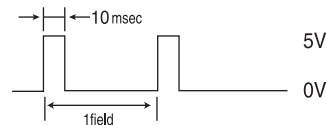

• SERIES OUTPUT Terminal

During recording, when the end of the tape is reached, the output becomes DC 5V.

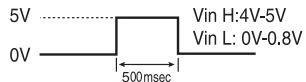

• SERIES INPUT Terminal

If the input becomes DC 5V for 200 msec or more, the VCR starts series recording.

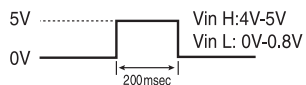

• WARNING OUTPUT Terminal

1) "High"

If the error display on the display panel continues to flash, the output becomes DC 5V. If the STANDBY/ON (POWER) button is pressed, the emergency mode is released, then the output becomes 0V.



2) "Low"

If the error display on the display panel continues to flash, the output becomes 0V. If the STANDBY/ON (POWER) button is pressed, the emergency mode is released, then the output becomes DC 5V.



If you are also using a Multiplexer, use the following diagrams as a guide to connecting the VCR for normal or alarm recording.

Connecting to a Multiplexer for Normal Recording

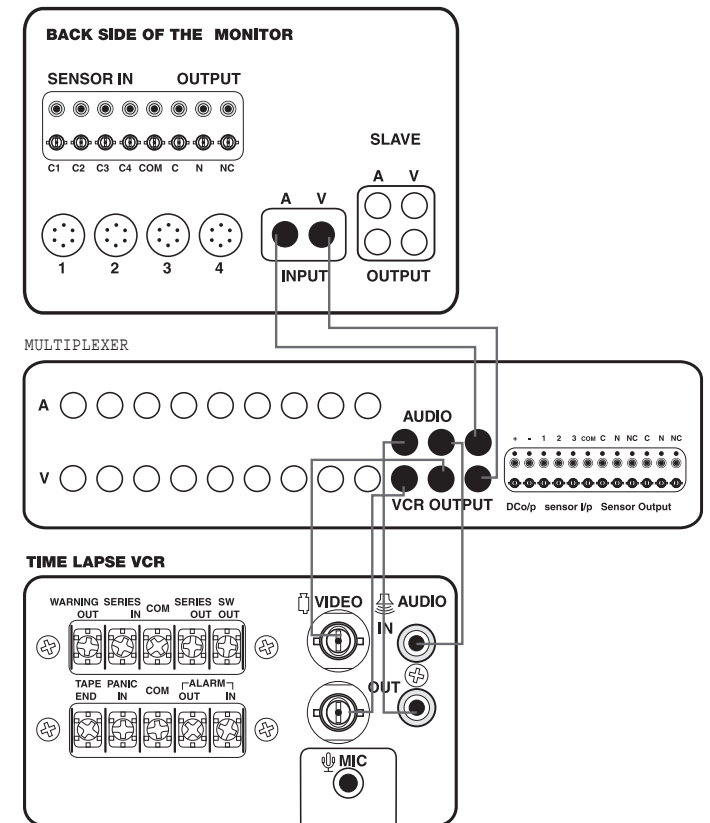

Connecting to a Multiplexer for Alarm Recording

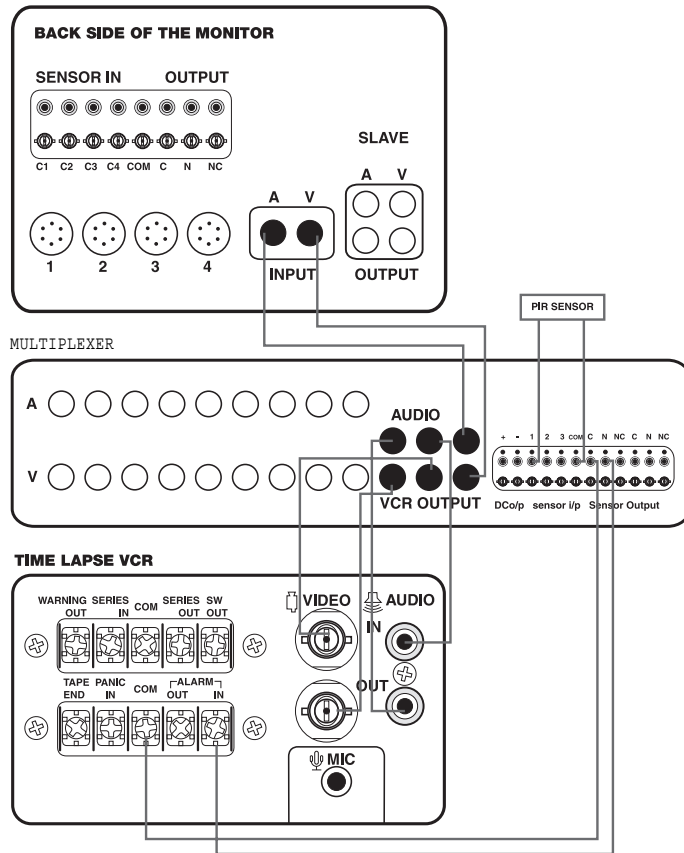

Daily Inspection

The following daily inspections are recommended in order to assure long-term and trouble-free operation of the unit.

The daily inspections are particularly important if using autorepeat recording.

Inspection Procedure



- If the security lock is engaged, it has to be released before proceeding with the inspection.
- If any problem is discovered during the inspection, unplug the power cord and consult your dealer.

- 1 Turn on the power to the camera, TV monitor and other connected devices.
- 2 Check that the image received on the TV monitor is correct.
- 3 Check that the on-screen display of the date and time is correct.
- 4 Press the REW button to rewind the recorded tape a few seconds.
- 5 Press the PLAY button and check that the playback image is correct.
 - Check in particular playback of time lapse recording (18 or 24 hour mode).
- 6 Check that the recorded date and time are correct.

Troubleshooting Guide

If the unit does not operate normally when you follow the instructions indicated in the manual, please refer to the table below.

SYMPTOM	POSSIBLE CAUSE	CORRECTIVE ACTION
No power.	The power cord is not correctly connected to the wall outlet. The unit is in timer recording stand-by mode.	- Connect the power cord firmly into the wall outlet. - This is normal, not a malfunction.
No image displayed on the monitor TV.	The connections are not correct. The power to the camera and/or monitor TV is not turned on.	- Check that all connections are correct. - Turn all connected devices power on.
The buttons do not respond.	The unit is in timer recording stand-by mode. Alarm recording. Panic recording. The security lock (SET LOCK) is engaged.	- Press the STANDBY/ON (POWER) button. - Wait for the alarm recording to end. - Press the STOP button for 3 seconds to stop. - Wait for the panic recording to end. - Press the STOP button for 3 seconds to stop. - Cancel the security lock.
Unit will not go into record mode.	The loaded cassette has no erasure prevention tab.	- Load a cassette tape with erasure prevention tab or cover the tab hole with adhesive tape.
Autorepeat.	“NO” is selected for autorepeat recording in the REC MODE SET menu. During autorepeat recording when there is an alarm input, autorepeat recording is canceled.	- Be sure to select “YES” for autorepeat recording. - Set “YES” again for autorepeat recording.

SYMPTOM	POSSIBLE CAUSE	CORRECTIVE ACTION
Timer recording.	The date and time are not correct. The unit is not set to timer recording stand-by mode. “N” is selected for the TIMER PROGRAM SET.	- Set the date and time correctly. - Press the STANDBY/ON (POWER) button to display “☐” on the display panel. - Be sure to select “Y” for the TIMER PROGRAM SET.
Alarm recording.	“NO” is selected for alarm recording in the ALARM REC SET menu.	- Be sure to select “YES” for alarm recording.
Noise in the playback picture.	The tracking adjustment is in the wrong. The video heads need cleaning.	- Adjust it by using the manual tracking. - Clean the video heads.
The date and time are not recorded.	“NO” is selected for the date and time in the DISPLAY SET menu. The date and time go off the ON-SCREEN by pressing the DISPLAY button.	- Be sure to select “YES” for the display. - Press the DISPLAY button to show the date and time.
The cassette tape cannot be ejected	Problem with the system or tape.	- Unplug the power cord then plug it back in.

Periodic Inspection and Maintenance

Periodic inspection and maintenance should be referred to your dealer. If there is noise in the playback picture, and it cannot be corrected using the tracking control, it may indicate that the video heads need cleaning. The video heads should be cleaned and inspected every 1,000 hours. The video heads usage can be checked using initial menu, running time.

System Down

If the unit does not function at all, try the following.

- 1 Unplug the power cord then plug it back in.
- 2 Reset the memory. (Press the RESET button. Under normal conditions, do not touch the RESET button.)
- 3 If the problem is not corrected after performing steps 1 and 2, consult your dealer.



- Press the RESET button for more than 0.5 seconds to perform the reset. Running Time will not be reset.

Specifications

General Specifications

Recording method	Dual-azimuth 4-head rotating helical scanning system
Audio recording	In 2, 6, 18 and 24 hour modes
Tape speed	33.35 m/sec (2 hour mode)
Specified video cassette tape	VHS 1/2 inch video cassette tape
Recording/playback time	2, 6, 18, 24, 36, 48, 72, 96, 120, 168, 240, 360, 480, 720, 960 hours (when using T-120 tape)
Fast forward/rewind time	Within 3 minutes (when using T-120 tape)
Television system	NTSC color TV system

Video

Recording method	Luminance signal : FM recording ~0.8V Down-converted subcarrier phase shift system
Video input	1 Vp-p, BNC, 75 Ω , unbalanced
Video output	1 Vp-p, BNC, 75 Ω , unbalanced
Horizontal resolution	Black & white mode 350 lines Color mode 300 lines

Audio

Input	RCA pin jack more than 47k Ω -8.8dBm, unbalanced
Output	RCA pin jack less than 1.5k Ω -7.8dBm, unbalanced
Microphone input	-60 dBs, 3.5mm mini jack, 10k Ω , unbalanced

Connectors

Alarm input	DC 4~5V(Open), DC 0~0.8V(Closed)/5.7k Ω
Alarm output	DC 4~5V(H), DC 0~0.8V(L)/5.7k Ω
Panic input	DC 4~5V(Open), DC 0~0.8V(Closed)/5.7k Ω
End output	DC 4~5V(H), DC 0~0.8V(L)/5.7k Ω
Warning output	DC 4~5V(H), DC 0~0.8V(L)/5.7k Ω
Series input	DC 4~5V(H), DC 0~0.8V(L)/5.7k Ω
Series output	DC 4~5V(H), DC 0~0.8V(L)/5.7k Ω
Switch output	DC 4~5V(H), DC 0~0.8V(L)/5.7k Ω
Common	0V(GND)

Other Specifications

Operating temperature range	41°F - 104°F
Operating humidity range	80% or less
Power requirements	AC 90-240V, 60 Hz
Power consumption	17W
Dimensions	360(W) x 90(H) x 289(D)
Weight	approximately 4kg

NOTE : The specifications and external appearance of this unit are subject to change without notice.

MAINTENANCE LOG

DATE : _____ RUNNING TIME : _____

SERVICE PERFORMED : _____

DATE : _____ RUNNING TIME : _____

SERVICE PERFORMED : _____

DATE : _____ RUNNING TIME : _____

SERVICE PERFORMED : _____

DATE : _____ RUNNING TIME : _____

SERVICE PERFORMED : _____

DATE : _____ RUNNING TIME : _____

SERVICE PERFORMED : _____

Warranty

Security Labs Incorporated warrants each new electronic product manufactured by it to be free from defective material and workmanship and agrees to remedy any such defect or to furnish a new part (at the Company's option) in exchange for any part of any unit of its manufacture which under normal installation, use and service disclosed such defect, provided the unit is delivered by the owner to us or to our authorized distributor from whom purchased or authorized service station intact, for our examination with all transportation charges prepaid to our factory. To establish and receive warranty service at our factory or authorized service facilities, proof of purchase/dated sales invoice is required. An authorization number must be obtained before any merchandise is returned to the factory.

This warranty does not extend to any of our electronic products which have been subjected to misuse, neglect, accident, incorrect wiring not our own, improper installation, unauthorized modification, or used in violation of instructions furnished by us, nor units which have been repaired or altered outside of our factory, nor to cases where the serial number thereof has been removed, defaced or changed.

This warranty is in lieu of all warranties expressed or implied and no representative or person is authorized to assume for us any other liability in connection with the sale of our electronic products.

SECURITY LABS, INC. DOES NOT ASSUME LIABILITY FOR ANY VIOLATION OF PRIVACY FROM ILLEGAL RECORDINGS MADE ON THIS UNIT. THE USER/OWNER ASSUMES FULL LIABILITY FOR ANY AND ALL RECORDINGS MADE FROM THIS UNIT IN A SECURITY OR SERVEILLANCE OPERATION OR IN ANY OTHER USE. SECURITY LABS IS NOT RESPONSIBLE FOR RECORDINGS THAT VIOLATE LAWS OR THAT MAY PROVE OFFENSIVE OR TEND TO INCRIMINATE ANOTHER INDIVIDUAL. LOCAL, STATE, AND FEDERAL LAWS MUST BE OBSERVED REGARDING ALL RECORDINGS.

SECURITY LAB'S OBLIGATION UNDER THIS WARRANTY SHALL BE TO REPLACE SUCH PARTS AND PROVIDE LABOR AS STATED. SECURITY LABS WILL NOT BE LIABLE FOR ANY LOSSES OR INCONVENIENCES DIRECT OR INDIRECT, OR CONSEQUENTIAL PROPERTY DAMAGES.

Over-the-counter exchange of initially defective units

A unit is described as initially defective when the dealer opens the unit and finds that it is inoperative or a customer opening a new unit finds that it is initially defective. This unit may be returned to the factory for exchange with prior authorization. Please call our customer service center to obtain a return authorization number.

Model	Parts	Labor	Video Heads
SL820	1 Year	1 Year	6 months



This instrument is listed by Underwriter's Laboratories, Inc. It is designed and manufactured to meet rigid U.L. safety standards against X-radiation, fire, casualty and electrical hazards.

security labs

15540 Herriman Blvd. - Noblesville, IN 46060

* For Customer Service and Technical Assistance
call toll free 1-800-774-0284.

** www.security-labs.com
